

FIBER-OPTIC PRODUCTS

19" FIXED FIBER-OPTIC SPLICE BOX

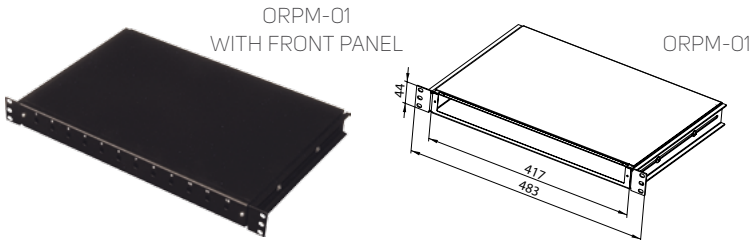

- Type: fixed
- Height: 1U
- Modular front panels not included (see below)
- Up to 24 positions for FO couplings
- Front panel must be selected and ordered separately
- Cable entry openings in rear

- Holes not in use can be covered with blank modules
- Installed in racks with adjustable holders
- Installation kit for splice cassettes and inner organizer (included)
- Wide range of accessories (optional)
- Color: powder-coated RAL 9005

- Package includes:
 - ORPM-01: 1x fibre-optic box, 2x cable holders, 2x 19" brackets, 4x screws M5, 2x screws M4
 - OR-xxxx: 1x front panel

Code	H (in U)	W	D (mm)	Description	Package
ORPM-01	1	19"	300	Fixed	1 pc



ACCESSORIES FOR FIBER-OPTIC SPLICE BOXES		
Code	Description	Package
ORO-K2000	Splice cassette	1 pc
ORO-PG11	PG11 coupling	10 pcs
ORO-PG16	PG16 coupling	10 pcs
ORO-ZPG11	Cover of opening for PG11 coupling	10 pcs
ORO-ZPG16	Cover of opening for PG16 coupling	10 pcs
ORO-01	Front organizer for ORPM	1 pc
ORO-02	Front organizer for ORVM	1 pc
ORO-03	Rear organizer	1 pc

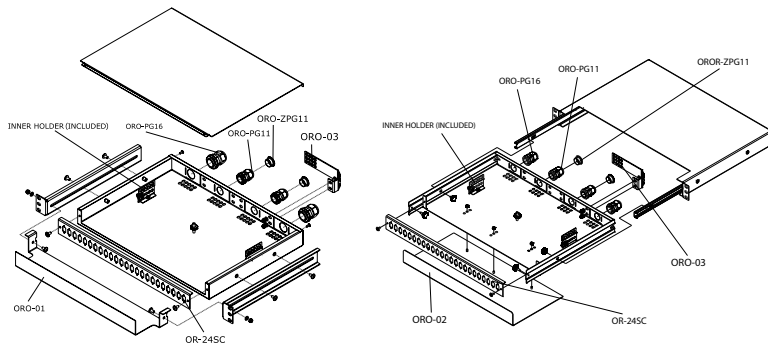

Code	Number of holes for FO couplings				Package
	8	12	16	24	
OR-xxST	yes	yes	yes	yes	1 pc
OR-xxSC	yes	yes	yes	yes	1 pc
OR-xxDSC	yes	yes	yes	yes*	1 pc
OR-xxFC	yes	yes	yes	yes	1 pc
OR-xxFCD	yes	yes	yes	yes	1 pc

* Without numbering and holes for screws

Note: All dimensions in mm

19" TELESCOPIC FIBER-OPTIC SPLICE BOXES



ORVE-01-250

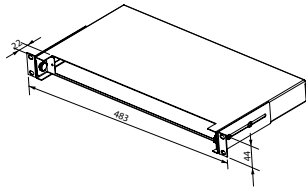

Code	H (in U)	W	D (mm)	Description	Package
ORVM-01	1	19"	320	Telescopic	1 pc
ORVE-01-250	1	19"	250	Telescopic	1 pc

- Used to terminate optical cables in racks
- Type: telescopic
- Height: 1U
- Modular front panels not included – see table on page 115
- Up to 24 positions for FO couplings
- Front panel must be selected and ordered separately

- Cable entry openings in rear
- Holes not in use can be covered with blank modules
- Installs into racks with two sliding holders
- Installation kit for splice cassettes and inner organizer included (ORVM-01 only)
- Wide range of accessories (optional)
- Color: powder-coated RAL 9005

- Package includes:
 - ORVM-01: 1x fibre-optic box, 2x cable holders, 2x screws M4
 - ORVE-01-250: 1x fibre-optic box, 2x 19" brackets, 6x screws M4

WALL-MOUNTING FIBER-OPTIC SPLICE BOXES

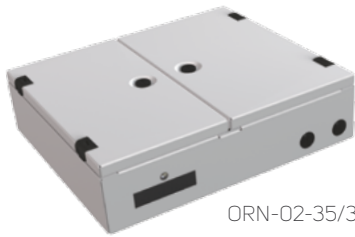

ORN-02-35/30

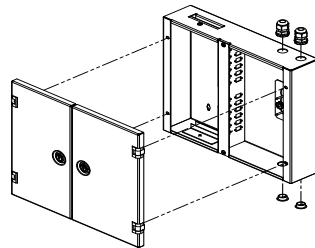

ORN-01

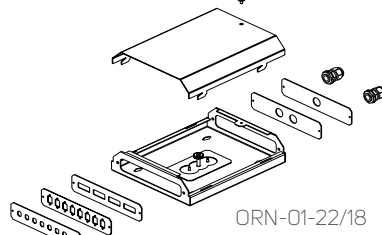

ORN-01-22/18

Code	Type	W x H (mm)	Package
ORN-01-30/18	Single	300x180	1 pc
ORN-01-22/18	Single	220x180	1 pc
ORN-02-35/30	Double	350x300	1 pc

PANELS FOR WALL-MOUNTING FIBER-OPTIC SPLICE BOXES		
ORN-01-30/18 and ORN-01-22/18	ORN-02-35/30	Package
ORN-M-8ST	ORN-24ST	1 pc
ORN-M-8SC	ORN-24SC	1 pc
ORN-M-4DSC	ORN-12DSC	1 pc
ORN-M-1PG	ORN-24FC	1 pc
ORN-M-2PG	ORN-12FCD	1 pc
ORN-M-8FC	-	1 pc
ORN-M-4FCD	-	1 pc

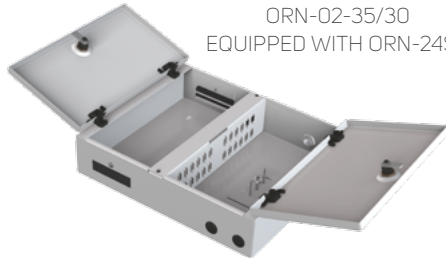

ORN-02-35/30
EQUIPPED WITH ORN-24SC



ORN-01-30/18

- Wall-mounting fiber-optic splice boxes (used to terminate optical cables)
- Types:
 - double – size 350x300 mm; equipped with double-leaf door and lock
 - single – size 300x180 mm or 220x180 mm
- Modular panels with holes for couplings – see table below (must be ordered separately)
- In double FO splice-box up to 24 positions for ST or SC or FC or 12 DSC or FCD adapters

- In single FO splice-box up to 8 positions for ST or SC or FC or 4 DSC or FCD adapters
- Holes not in use can be covered with blank modules
- Cable entry through PG couplings (PG 9 for ORN-01 and PG 11 for ORN-02)
- Installation kit for splice cassette (ORO-K2000) included
- Color: powder-coated RAL 7035

- Package includes:
 - ORN-01-xx/xx: 1x WM box (box with cover), 1x screw M4, 4x screws M3, 1x nut M5
 - ORN-02-xx/xx: 1x WM box (box with 2 doors), 2x PG11 with nuts, 2x Cover of opening for PG, 2x screws M4, 1x nut M5
 - ORN-M-xxxx, ORN-xxxxx: 1x panel

TYPES OF HOLES FOR FIBER-OPTIC CONNECTORS:

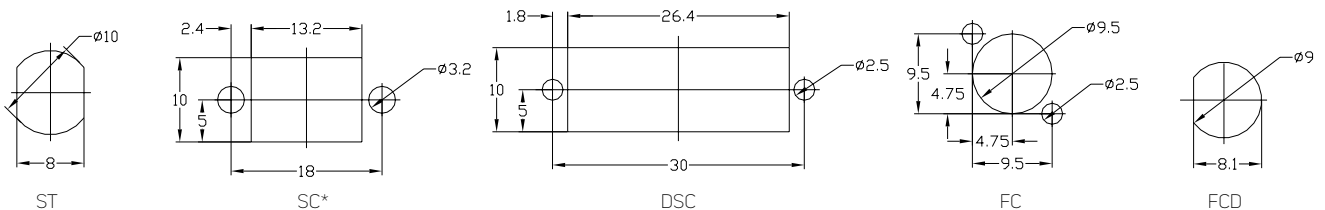

* Used also for DUAL-LC (adapter needed)

Note: Dimensions in mm (before powder coating)

www.conteg.com



CONTEG, spol. s r.o.

Headquarters:

Na Vítěznej pláni 1719/4
140 00 Prague 4
Czech Republic
Tel.: +420 261 219 182
conteg@conteg.com
www.conteg.com

Production plant:

K Silu 2179
393 01 Pelhřimov
Czech Republic
Tel.: +420 565 300 300

Local Branches/Offices:

Austria/Germany/Switzerland:	+420 261 219 182
Benelux:	+31 76 5420 709
Southeastern Europe:	+49 172 8484 346
Finland:	+358 50 414 1257
France/Italy/Maghreb:	+33 1 60 04 55 90
Middle East:	+971 55 508 3241
Russia/CIS:	+7 495 967 3840
Saudi Arabia:	+966 54 000 2341

CONTEG