

Outdoor ColorPro

Outdoor ColorPro Night Vision Pan Tilt Network Camera

MODEL: VIGI C540S



4MP | H.265+

VIGI C540S



ColorPro
Night Vision



Face
Recognition*



People & Vehicle
Analytics*



Human & Vehicle
Classification



Smart Detection



Powerful Pan Tilt

// Face Recognition

Efficiently enhances access management and attendance control while better protecting privacy*.

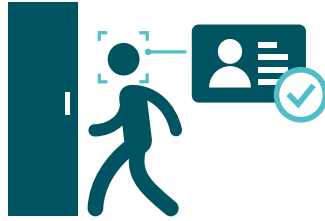

// People & Vehicle Analytics

Quickly find people or vehicles of interest using various attributes, greatly improve your search efficiency*.

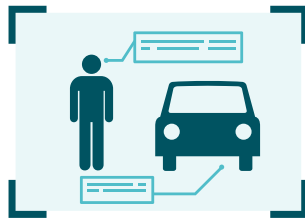

// Human & Vehicle Classification

Intelligently distinguishes humans and vehicles from other objects, so you receive more accurate event notifications.



// Smart Detection



Motion Detection

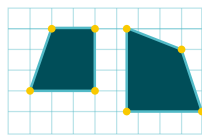

Region Intrusion
Detection



Object Removal
Detection



Region Exiting
Detection

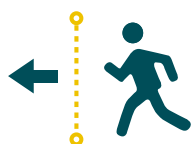

Line-Crossing
Detection



Camera Tampering
Detection



Object Abandoned
Detection



Region Entering
Detection

// Flexible Pan Tilt

- Customized Patrol
- Power-Off Memory Function
- Auto Tracking
- Remote Monitoring & Configuration

// VIGI Surveillance Solution

The VIGI professional surveillance system by TP-Link is dedicated to protecting the business that you've worked hard to build—whenever, wherever.

Outstanding functions, reliable quality guarantees, and simplified installation work together to ensure your business stays safe and sound.

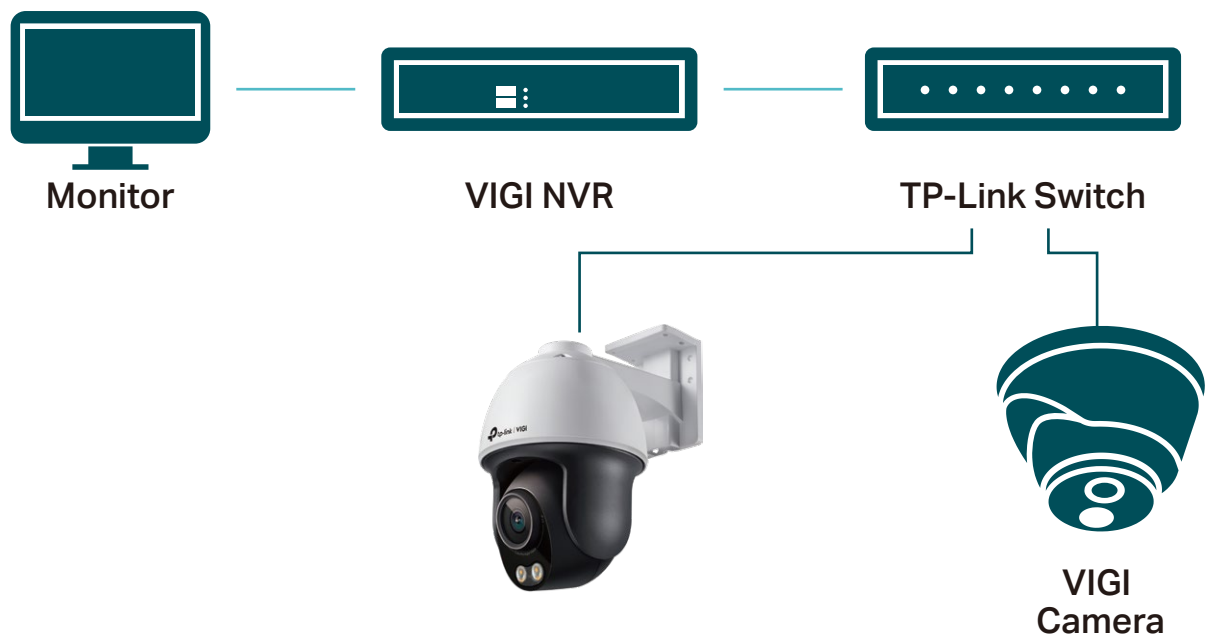

// Flexible Installation

Find the perfect vantage point by simply securing your camera to the ceiling, wall, or pole**.

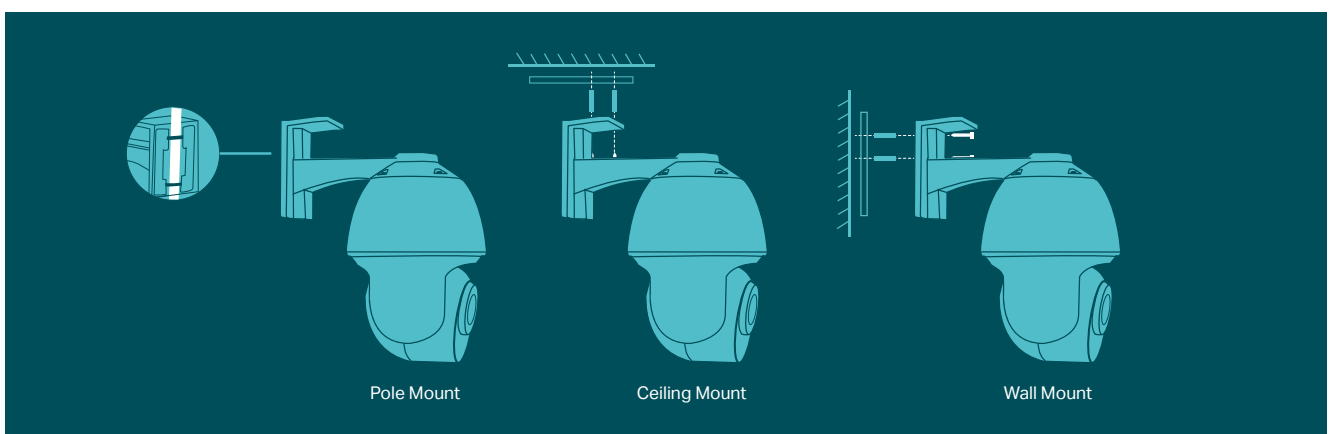

// Specifications

Camera	
Product Model	VIGI C540S
Image Sensor	1/1.79" Progressive Scan CMOS
Min. Illumination	0.0005 Lux; 0 Lux with white light
Shutter Speed	1/3 to 1/10000 s
Slow Shutter	Yes
Day & Night Mechanism	N/A
Day/Night Switch	Unified/Scheduled/Auto
Lens	
Focal Length	4 mm
Aperture	F1.0±5%
FOV	Horizontal FOV: 104°, Vertical FOV: 55°, Diagonal FOV: 127°
Lens Mount	M16*P 0.5
DORI Distance	4 mm: Detect: 63 m (207 ft) Observe: 26 m (86 ft) Recognize: 13m (41 ft) Identify: 6 m (21 ft)
PTZ	
Pan/Tilt Range	Pan: 0° to 348°, Tilt: 0° to 105°
Pan/Tilt Speed	Pan Speed: Configurable from 8° to 44°/s; Preset Speed: 44°/s Tilt Speed: Configurable from 8° to 44°/s; Preset Speed: 44°/s
Manual Control Speed	Configurable from 8° to 35°/s
Presets	300
Patrol Scan	8 patrols, up to 8 presets for each patrol
Power-off Memory	Yes; Auto restore to previous PTZ and lens status after power failure
Park Action	Yes; Preset; Patrol Scan
3D Positioning	Yes
Illuminator	
IR LED	N/A
White LED	Quantity: 2 Range: 30m
Illuminator On/Off Control	Auto/Scheduled/Always on/Always off
Video	
Max. Resolution	2688x1520

Main Stream	<p>Frame Rate: 50Hz: 1fps, 5fps, 10fps, 15fps, 20fps, 25fps 60Hz: 1fps, 5fps, 10fps, 15fps, 20fps, 25fps, 30fps</p> <p>Resolution: 2688x1520, 2560x1440, 2304x1296, 2048x1280, 1920x1080, 1280x720</p>
Sub-Stream	<p>Frame Rate: 50Hz: 1fps, 5fps, 10fps, 15fps, 20fps, 25fps 60Hz: 1fps, 5fps, 10fps, 15fps, 20fps, 25fps, 30fps</p> <p>Resolution: 704x576, 640x480, 352x288, 320x240</p>
Bit Rate Control	CBR, VBR
Video Compression	Main stream: H.265/H.265+/H.264/H.264+ Sub-stream: H.265/H.264
H.264 Type	High Profile
H.264+	Main Stream Supported
H.265 Type	Main Profile
H.265+	Main Stream Supported
Video Bit Rate	Main Stream: 256 Kbps to 6 Mbps Sub-Stream: 64 Kbps to 512 Kbps
Image	
Image Settings	Mirror, Brightness, Contrast, Saturation, Sharpness, Exposure, WDR, White Balance, Prevent Overexposure to Infrared Light, HLC Adjustable by Client Software
Image Enhancement	BLC, HLC, 3D DNR
Wide Dynamic Range (WDR)	120dB Note: When Face Recognition s is enabled, only DWDR is supported.
SNR	≥ 52 dB
Image Parameters Switch	Yes
Privacy Mask	Up to 4 Masks
ROI	1 Region
OSD Setting	Yes
Audio	
Audio Communication	Two-way audio
Audio Input	Yes
Audio Output	Yes
Audio Compression	Yes
Audio Sampling Rate	8KHz
Environment Noise Filtering	Yes
Audio Bit Rate	64 Kbps(G.711 alaw)

Network	
Protocols	TCP/IP, UDP, ICMP, HTTP, HTTPS, DHCP, DNS, RTSP, NTP, UPnP, UDP, SSL/TLS, FTP/SFTP, RTP, IPv4, IPv6, ARP
API	Open Network Video Interface (Profile S)
Web Browser	Google Chrome® 57 and above Firefox® 52 and above Safari® 11 and above Microsoft® Edge 91 and above
Security	Password Protection, HTTPS Encryption, IP Address Filter, Digest Authentication
Simultaneous Live View	3 Main Streams & 3 Sub-Streams
Client	VIGI App, VIGI Security Manager, Web UI
Cloud	Yes
ONVIF	Yes
Interface	
Network Interface	1 RJ45 10/100M Self-Adaptive Ethernet Port, PoE
On-board Storage	Built-In Memory Card Slot, Support MicroSD Card, Up to 512 GB†
Built-in Speaker	Yes
Built-in Microphone	Yes; Records Anything Going on within a 15-ft Radius of the Camera
Audio	N/A
Alarm	N/A
Reset Button	Yes
Power	DC Power Port
Alarm and Event Management	
Smart Event	Human & Vehicle Classification, Intrusion Detection, Line-Crossing Detection, People Detection, Vehicle Detection, Region Entering Detection, Region Exiting Detection, Object Abandoned Detection, Object Removal Detection, Loitering Detection, People Detection, Vehicle Detection, Abnormal Sound Detection, Scene Change Detection
Basic Event	Motion Detection, Video Tampering Detection, Exception (Illegal Login)
Alarm Linkage	Memory Card Video Recording, Message Push, Audible Warning, White Light Flashing
Linkage Method	N/A
Output Notification	Message Push
Deep Learning Function	
People & Vehicle Analytics	Search and filter to people or vehicle of interest based on many different attributes, making post-event search faster and easier*.
General	
Operating Temperature	-30–60 °C
Storage Temperature	-40–60 °C

Operating Humidity	95% or Less (Non-condensing)
Storage Humidity	95% or Less (Non-condensing)
Power Supply	12V DC \pm 5%, Max. 13.13 W, 5.5mm Coaxial Power Plug PoE: 802.3at, class 4, Max. 16.47 W
Material	Plastic
Protection	IP66
Product Dimensions (L x W x H)	120*172*203mm
Package Contents	VIGI Network Camera Quick Start Guide Waterproof Cable Attachments Mounting Accessories
Net Weight	0.59 Kg
Gross Weight	0.94 Kg
Certifications	CE, NTRA, VCCI, KC, BSMI, FCC, IC

Dimensions

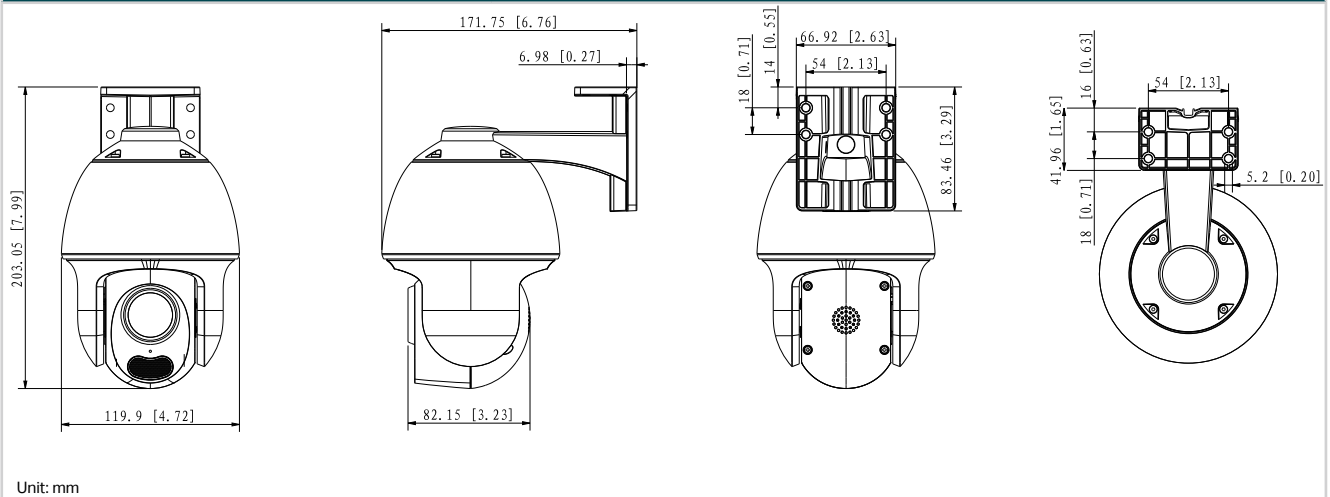

*This function must be used with VIGI specified software.

**Pole mounting kits are not included in the package.

†Micro SD card is not included in the package.

‡Calculations based on laboratory testing using VIGI cameras. Actual performance may vary according to the amount of activity recorded, resolution, and other variables.

Specifications are subject to change without notice and can be found at www.tp-link.com.

©2024 TP-Link