

DATASHEET

RJ45 Extension Cat.6A S/FTP LSZH AWG26 white 1m



General data

Shielded RJ45 patch cable extension Cat.6A for transmissions according to ISO11801 for up to 10Gbit/s.

You have already installed a patch cable in your study/office. Previously, the cable was sufficient up to your device, but now that the office has been remodelled, it is no longer sufficient. Instead of replacing the entire patch cable because it has been laid at great expense, simply connect the RJ45 patch cable extension in the length that suits you to your end device.

In addition, the short version of the patch cable extension can be used to protect your device connections. Especially in the home office, with a lot of assembly and disassembly of the e.g. notebook, the socket of the notebook is heavily stressed. This can be circumvented by "interposing" the patch cable extension, because here you are then stressing the socket of the extension.

The RJ45 patch cable extension Cat.6A can be used with any conventional devices with RJ45 interface, such as computers, notebooks, DSL modems, routers, switches, game consoles, televisions and many more.

Allgemeine Daten

Suitable for degree of protection (IP)	IP20
Cable type	S/FTP
Pin assignment	1:1
Locking lever	True

This datasheet was created automatically on 19-01-2024 . Technical changes reserved.



DATASHEET

RJ45 Extension Cat.6A S/FTP LSZH AWG26 white 1m

Model	Shielded
Material outer sheath	LSZH
Allocation	acc. TIA/EIA 568B
Colour anti-kink sleeve	white
Connector type	RJ45 Standard
Area of Application	Industrial Ethernet
Length imprint	True
Anti-kink sleeve	plugged in
Current Rating	max. 1 A
Contacts	3 μ " gold plated
Colour outer sheath	white
Category	6A (TIA)

Mechanische Eigenschaften

Conductive shield	Selected shield contact
Mating cycles	750

Kabelaufbau

Type of connector connection 2	RJ45 8(8)
Type of connector connection 1	RJ45 8(8)
Conductor Material	Copper
Raw cable	Cat.6A
AWG-size	26/7
Cable construction	4x2

Kabelmantel

Printing	www.efb-elektronik.de
Outer diameter of the cable	6.2 mm

Umgebungsbedingungen

Temperature Range (Operation)	-15 - 60 °C
Temperature Range (Storage)	-20 - 75 °C

Elektrische Eigenschaften

Insulation Resistance	10 M Ω
Contact Resistance	30 m Ω

This datasheet was created automatically on 19-01-2024 . Technical changes reserved.



DATASHEET

RJ45 Extension Cat.6A S/FTP LSZH AWG26 white 1m

POE class	PoE+ acc. to IEEE802.3at
Operating-/ tempering voltage	max. 50 V DC

Übertragungstechnische Eigenschaften

Transmission	5Gbit
Bandwidth	500MHz

Normen, Zulassungen, Zertifizierungen

Cabling standard	EN50173
Connector	IEC 60603-7-51

Available variants

ArtNr.	Bezeichnung	Length	Längentoleranz
K5546WS.1	RJ45 Extension Cat.6A S/FTP LSZH AWG26 white 1m	1.0 m	±5 %
K5546WS.2	RJ45 Extension Cat.6A S/FTP LSZH AWG26 white 2m	2.0 m	±5 %
K5546WS.3	RJ45 Extension Cat.6A S/FTP LSZH AWG26 white 3m	3.0 m	±5 %
K5546WS.5	RJ45 Extension Cat.6A S/FTP LSZH AWG26 white 5m	5.0 m	±5 %
K5546WS.10	RJ45 Extension Cat.6A S/FTP LSZH AWG26 white 10m	10.0 m	±5 %

Drawings

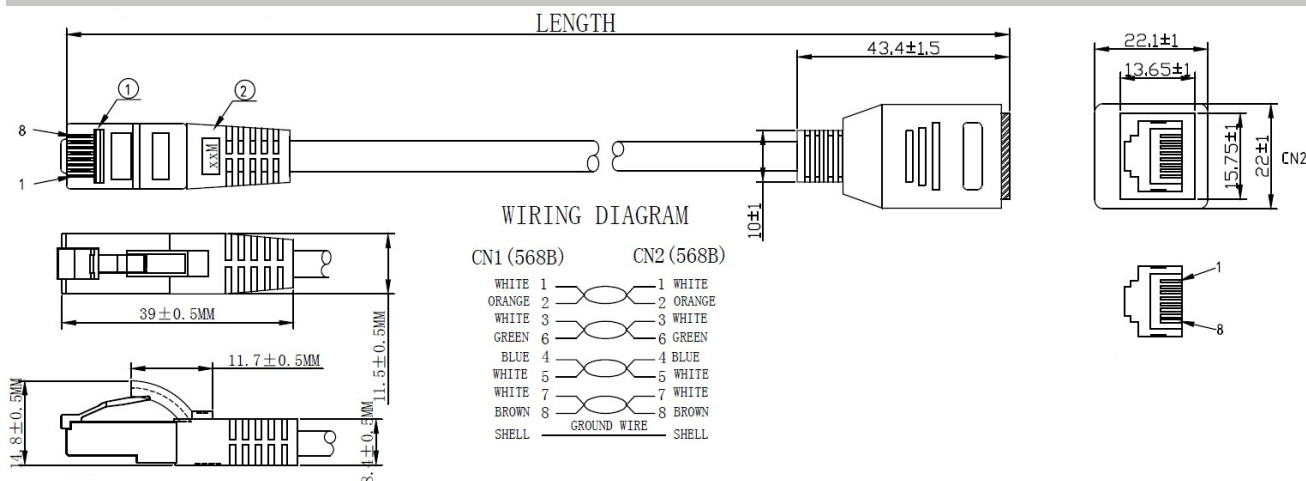

This datasheet was created automatically on 19-01-2024 . Technical changes reserved.