

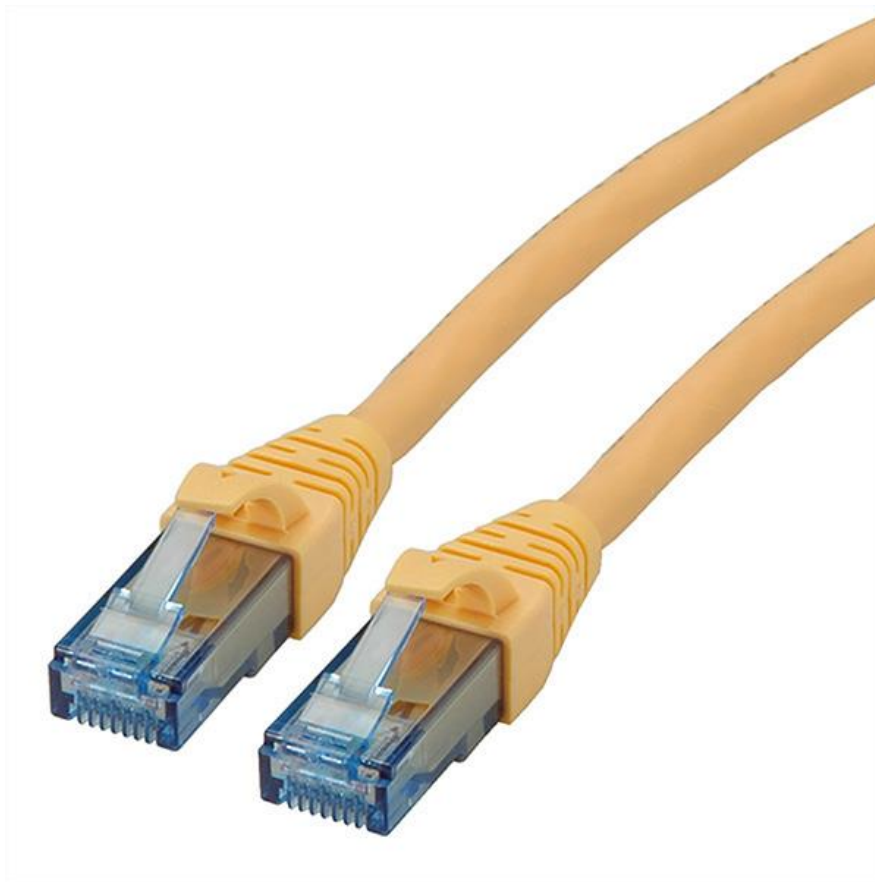

Datenblatt - Fiche technique - Data sheet

21.15.2723



ROLINE Patchkabel Kat.6A UTP, Component Level, LSOH, gelb, 3,0 m

Cordon ROLINE UTP Cat.6A / 10 Gigabit, Component Level, LSOH, jaune, 3,0 m

ROLINE UTP Patch Cord Cat.6A, Component Level, LSOH, yellow, 3.0 m

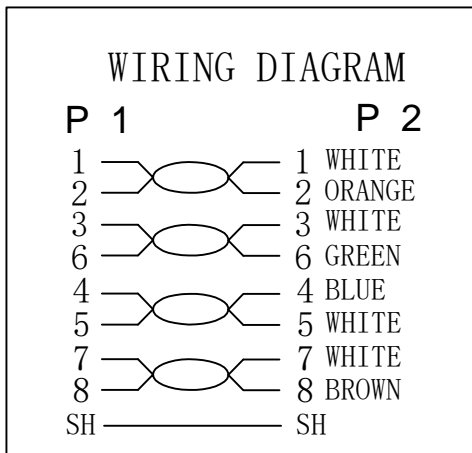
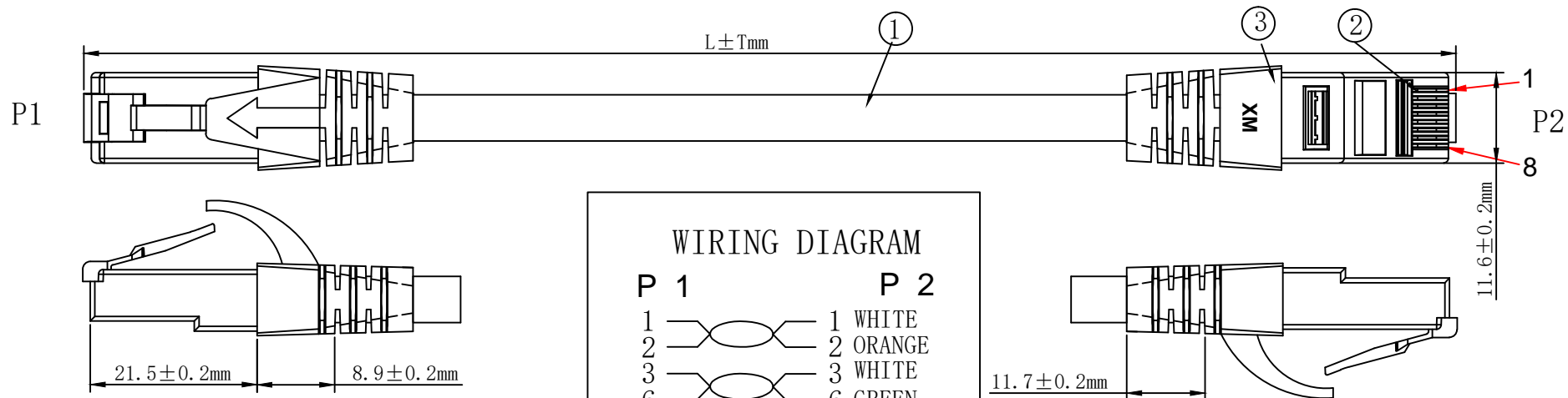

1. ELECTRICAL TEST:

- (1).100% OPEN SHORT & MISS WIRE TEST;
- (2).INSULATION RESISTANCE:DC 250V 20M OHM MIN;
- (3).CONTACTOR RESISTANCE:30 OHM MAX

2. PRINTING:GHMT® roline CAT.6A U/UTP COMPONENT PATCH CORD LSZH 500MHZ ISO/IEC

11801 & EN 50173-1 & ANSI/TIA-568-C.2

3.100% Component Patch cord Test PASS

4.Minimum bending radius:60mm

MATERIAL LIST

⑥	LABEL	NO DRY GLUE LABEL	1PCS	
⑤	MINI TIE	PE MINI TIE(POSSESS METAL)	2PCS	
④	POLYETHYLENE BAG	POLYETHYLENE BAG	1PCS	
③	OVER MOLD	88A PVC yellow	2PCS	
②	CONNECTOR	RJ45 8P8C'S UNSHIELDED PIN GOLD PLATED 3u", Transparent Blue	2PCS	
①	CABLE	S/FTP CAT.6A 26AWG (BC*1P+AL-FOIL)*4P+BRAID CABLE JACKET LSOH OD=6.2±0.2MM	1PCS	
NO.	PARTS NAME	SPECIFICATION STANDARD	QT' Y	REMARK

COLOUR:yellow (PANTONE:135C)

ITEM NO.	LENGTH (L)	TOLERANCE (T)
21. 15. 2983	300mm	± 10mm
21. 15. 2720	500mm	± 15mm
21. 15. 2721	1000mm	± 30mm
21. 15. 2724	1500mm	± 45mm
21. 15. 2722	2000mm	± 60mm
21. 15. 2723	3000mm	± 90mm
21. 15. 2725	5000mm	± 150mm
21. 15. 2726	7500mm	± 210mm
21. 15. 2727	10000mm	± 300mm
21. 15. 2728	15000mm	± 450mm
21. 15. 2729	20000mm	± 600mm

ITEM NO.	21. 15. 2983	21. 15. 2720	21. 15. 2721	21. 15. 2722	21. 15. 2723
21. 15. 2724	21. 15. 2725	21. 15. 2726	21. 15. 2727	21. 15. 2728	21. 15. 2729
DESC.	ROLINE U/UTP PatchCord CAT. 6A, LSOH, Comp. Level, yellow				

		NEW		2016-09-13	A
BY	CHK	REVISION RECORD MODIFICATIONS		DATE	REV.

